



VISHAY
PRECISION
GROUP



Product Overview

Web Tension Systems

BLH • Nobel Weighing Systems

Brands of VPG Process Weighing



Nobel
Elektronik

www.weighingsolutions.com

For over 40 years, VPG Process Weighing, through our brands BLH and Nobel Weighing Systems, has supplied web tension and force measurement systems for paper machines, the steel industry, and converting machines to customers all over the world. As a natural result of this, we have acquired solid knowledge and experience within these areas.

VPG Process Weighing is a leading manufacturer of products and systems for weighing and force measurement and control. Our web tension systems comprise standard modules and electronics, as well as customized systems. We design force measurement modules according to the customers' mechanical requirements and forces, ranging in size from just a few Newtons to mega-Newtons.

The combination of digital signal amplifiers and stable force transducers means that our systems can handle anything from applications with a low tare and large forces, to those with a large tare and small forces. Our HTU and other measurement modules measure forces on both the X and Y axes. By using our electronics, we can compensate for varying wrap angles.

From steel and paper to plastic films, we have installed thousands of standard and customized force and web tension systems. Our extensive knowledge helps us meet the present and future challenges.

Our experienced staff of sales engineers, system engineers, and service engineers understands your requirements and will provide solutions to meet your needs.

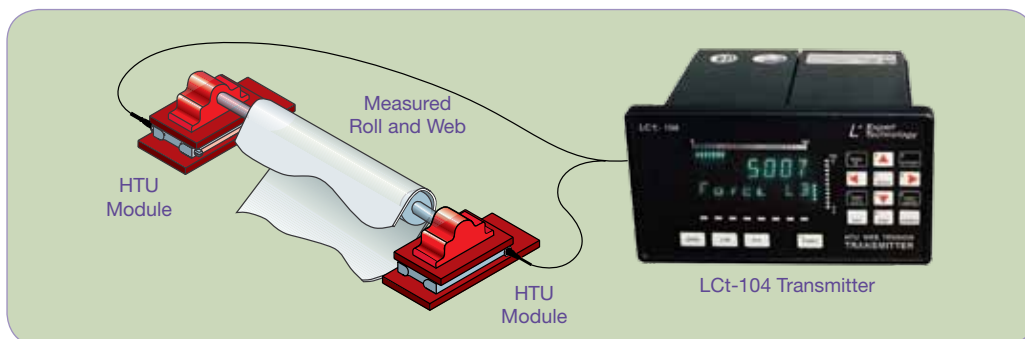
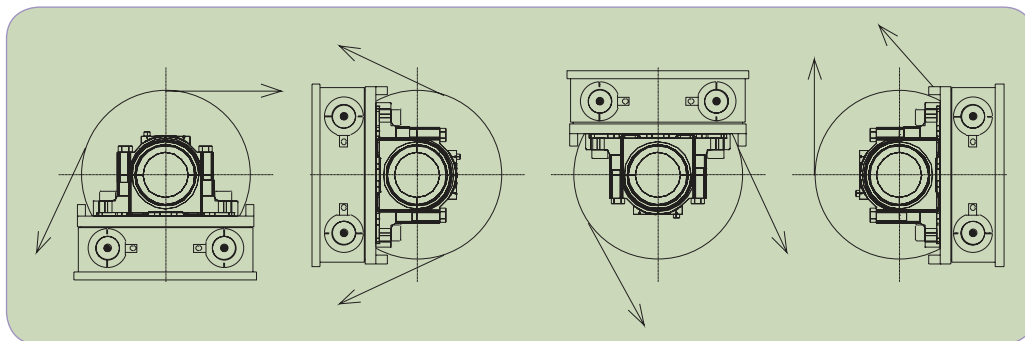





Features and Applications



Force and Web Tension Products



Products	Features	Applications
HTZ-3 	<ul style="list-style-type: none"> • Rugged stainless steel 'I' beam sensing section • Resultant forces measure in the up or down direction • Full Wheatstone bridge with Vishay SR-4® foil strain gages • Factory calibration eliminates need for on-site test weights • Optional adapter plate designed for on-site installation of overload safety stops • FM and CSA approved 	<ul style="list-style-type: none"> • Paper producing machines • Roofing shingle manufacturing • Printing presses • Laminator zones • Dryer zones • Coating zones • Felt measurement
GLT and LTT 	<ul style="list-style-type: none"> • 90 N to 2200 N • Low tension applications • Direct shaft measurement 	<ul style="list-style-type: none"> • Web tension plastic film or woven material • Web tension filament • Tension measurement printing press
KIS Force Transducer 	<ul style="list-style-type: none"> • 1 kN to 500 kN • Medium forces • Replaces existing shafts • Can be rotated to measure full resultant force 	<ul style="list-style-type: none"> • Web tension paper machine, steel strip plastic film, and woven material
KIP Force Transducer 	<ul style="list-style-type: none"> • 10 kN to 20 kN • Simple installation • Robust with low deflection 	<ul style="list-style-type: none"> • Web tension and tension profile measurement paper, plastic film, and woven material
HTU Measurement Module 	<ul style="list-style-type: none"> • Capacities from 2 Klb to 20 Klb (9 kN to 90 kN) • Dual-axis transducer design enables measurement of resultant force in all directions without limitation to horizontal or vertical components • Functional to 250°F (121°C) • Sealed to IP67: field-proven design • Low profile: direct load cell replacement with simple retrofit installation • Factory-calibrated for minimum start-up time 	<ul style="list-style-type: none"> • Web tension measurement paper, plastic film, and woven material • Nip force measurement • Felts • Dryers • Mining conveyers • Coaters • Laminators • Winders and rewinders
PST-2 Measurement Module 	<ul style="list-style-type: none"> • Capacities: 20 kN to 200 kN • Measure exact resultant web tension force • Allows for great thermal expansion of roller • Superior accuracy for heavy rolls with small wrap angles • Units customized to fit existing applications—no reconstruction required • High temperature units: functional to 100°C • Special units designed to meet any application need 	<ul style="list-style-type: none"> • Web tension measurement on steel strip in galvanizing or hardening/annealing furnace lines
FMU-1 Measurement Module 	<ul style="list-style-type: none"> • Measure exact resultant web tension force • Superior accuracy for heavy rolls with small wrap angles • Units customized to fit existing applications—no reconstruction required • High temperature units—functional to 100°C • Special units designed to meet any application need 	<ul style="list-style-type: none"> • Paper machines • Steel strip tension • Mining conveyers • Felts • Dryers • Calendars • Coaters • Laminators • Winders and rewinders
FMU-5 Measurement Module 	<ul style="list-style-type: none"> • Customized and compact unit for higher forces • Measure exact resultant web tension force • Superior accuracy for heavy rolls with small wrap angles • Units customized to fit existing applications—no reconstruction required • High temperature units—functional to 100°C 	<ul style="list-style-type: none"> • Paper machines • Steel strip tension • Mining conveyers • Felts • Dryers • Calendars • Coaters • Laminators • Winders and rewinders

Web Tension Products	 GLT/LTT	 HTZ-3	 HTK	 KIS	 KIP
Measurement Range	90 N to 2200 N	2.2 kN to 222 kN	0.5 kN to 5 kN	1 kN to 500 kN	10 kN to 20 kN
Repeatability	0.02% RO	0.01% RO	0.01% RO	0.01% RO	0.02% RO
Accuracy	0.05% RO	0.10% RO	0.05% RO	0.02% RO	0.1% RO
Overload	100% RL	50%	50% RL	100% RL	100% RL
Measurement Angle	All	180°	Symmetrical	All	±45 deg
Temperature Range	-40°C to +105°C	-40°C to +105°C	-40°C to +105°C	-40°C to +80°C*	-40°C to +80°C*
Material	Stainless steel	Stainless steel	Stainless steel	Alloy/stainless steel	Stainless steel
Protection Class	IP67	IP65	IP67	IP67	IP67
Electrical Connection	Bendix	Cable 10 m	Cable 10 m	Cable 5/10 m	Cable 5 m
Approvals	FM, CSA	FM, CSA	FM, CSA	OIML, ATEX	ATEX

*Up to 120°C, upon request.

Web Tension Products	 HTU	 PST-2	 FMU-1	 FMU-5
Measurement Range	9 kN to 90 kN	20 kN to 200 kN	2 kN to 200 kN	100 kN to 2000 kN
Repeatability	0.02% RO	0.01% RO	0.01% RO	0.02% RO
Accuracy	0.1% RO	0.1% RO	0.1% RO	0.1% RO
Overload	50% RL	100% RL	100% RL	100% RL
Measurement Angle	All	All	All	All
Temperature Range	-20°C to +150°C	-40°C to +80°C*	-40°C to +80°C*	-40°C to +80°C*
Material	Stainless steel	Alloy/stainless steel	Alloy/stainless steel	Alloy/stainless steel
Protection Class	IP67	IP67	IP67	IP67
Electrical Connection	Cable 10 m	Cable 5/10 m	Cable 5/10 m	Cable 10 m
Approvals	-	ATEX	ATEX	ATEX

*Up to 120°C, upon request.

Products	Features
G4 	<ul style="list-style-type: none"> • Multi-channel instrument • Measurement, summation, angle calculation, and regulation • Real time • Bandwidth 1 kHz
DXt-40 Series Web Tension Transmitter/Controllers 	<ul style="list-style-type: none"> • Continuous display of left, right, or total tension • Individually digitize each transducer in a multicell system for greater resolution and accuracy • Continuous diagnostics of system performance • Displays the resultant force and angle of inclination for any wrap angle (Model HTU)
LCp-100 Series Web Tension Indicator/Transmitter 	<ul style="list-style-type: none"> • Designed for precise high-speed applications (120 updates/second) • Connects easily to any PLC, DCS, or PC-based process control system • FM- and CSA-approved for Division 2 hazardous locations • CE-marked
PS-2010 	<ul style="list-style-type: none"> • High performance tension transmitter • DIN rail mount • 120 samples per second
AST 3PF 	<ul style="list-style-type: none"> • Single-channel instrument with high resolution • Installation via PC or panel
microPOS 	<ul style="list-style-type: none"> • Dual-channel instrument • Measurement, summation, angle calculation, and regulation
PS-1010T 	<ul style="list-style-type: none"> • Eliminates low tension signal drift • Simple system set up and calibration • Compact—lightweight DIN rail “snap track” installation • Independent zero and span adjustments • Bipolar uplifting or downward tension force measurement
DXt-15 	<ul style="list-style-type: none"> • Ruggedized, field mounted web tension transmitter • Integral multiple-transducer summing circuit • Digital filtering dampens vibration without reducing response time • 0 to 10 V, 4 to 20 mA, and RS-485 signal outputs • NEMA 4/4X enclosure standard
LCt-104 	<ul style="list-style-type: none"> • Individually digitized transducer forces for four web tension transducers (1-, 2-, or 4-zone configuration) • View left, right, and total; force, tension and angle values • 100% digital calibration—no dead weight loading and no strapping required • Online diagnostics significantly reduce downtime • Dynamic digital filtering for each tension zone • Total, individual, and difference output control signals • Four inputs, eight triac output relays, eight TTL logic outputs • Allen-Bradley Remote I/O, Modbus, DeviceNet, and Profibus interface

Steel Strip Winder with the FMU Web Tension Unit

Typical applications for the FMU unit:

- Paper machines
- Steel strip tension equipment
- Mining conveyors
- Felts, dryers, calendars, coaters, and laminators
- Winders and rewinders

FMU unit used in an annealing line for controlling the web tension of steel strip: The unit is mounted under the bearing and connected to a junction box and further to an instrument.

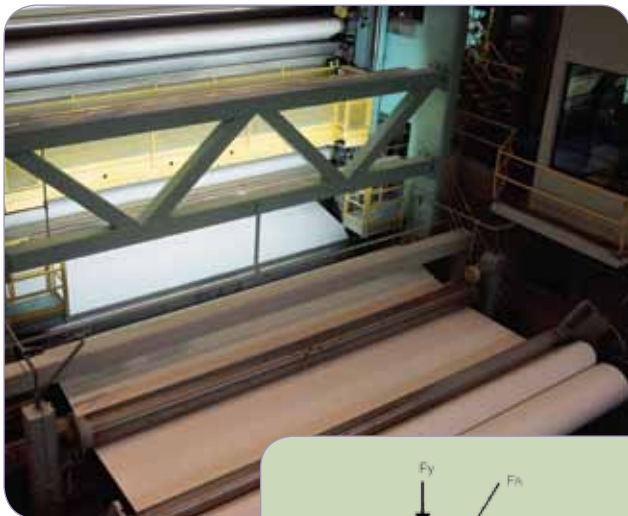
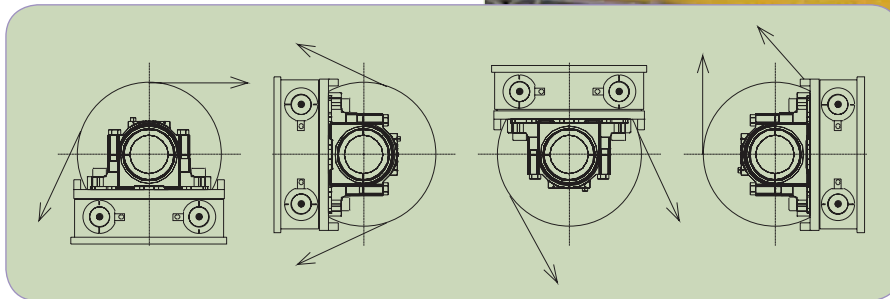

Paper Production with the HTU Web Tension Module

Typical applications for the HTU unit:

- Paper machines
- Steel strip tension equipment
- Wall paper
- Mining conveyors
- Felts, dryers, calendars, coaters, and laminators
- Winders and rewinders

Fitting the HTU module under the bearing to control web tension of paper during production: The HTU measures force in both vertical and horizontal directions. This makes it possible to calculate the exact web tension and resulting force, even in the presence of alternating web angles. The low height of the HTU module makes it easy to fit into existing machines under a pillow block.

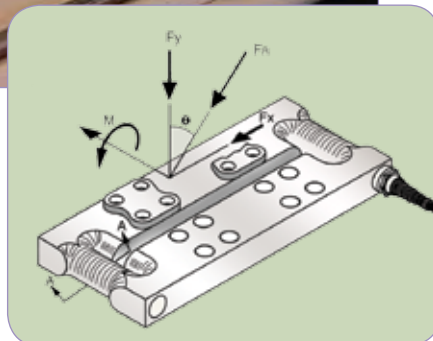

Shaft Installation with the KIS Force Transducer

Typical applications for the KIS unit:

- Paper tension
- Steel tension
- Plastic film, woven, or filament tension measurement

Replacing the shaft in a roller with internal bearing by a KIS load cell to measure the force caused by the tension in the paper or steel during production: Since the load cell can be rotated, the full resultant force can be measured.

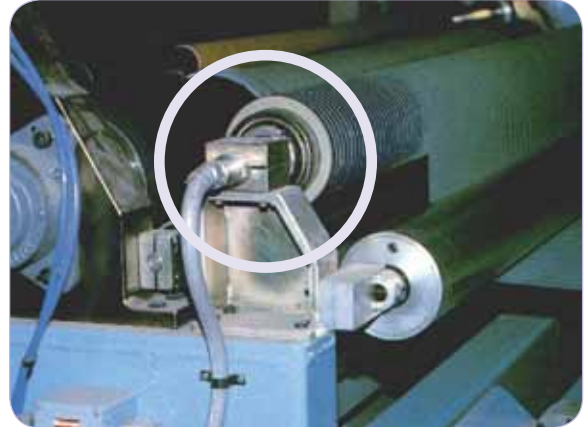

Shaft Installation with the GLT/LTT for Low Tension Measuring and Control

Typical applications for the GLT/LTT unit:

- Paper tension
- Tension in printing press
- Plastic film, woven, or filament tension measurement

Replacing the pillow block with a GLT or a LTT on a dead-end shaft roller to measure the force caused by the tension in the paper, plastic film, etc., provides highly accurate measurement of lower forces. The load cell can be rotated to measure the full resultant force.



PST-2 Installation on the Pillow Block

Typical applications for the PST-2 unit:

- Web tension steel strip in galvanizing and hardening/annealing furnace

PST web tension units placed underneath the pillow block to measure the web tension force: The design of the unit enables measurement on the roller with great thermal expansion without measuring disturbing forces.

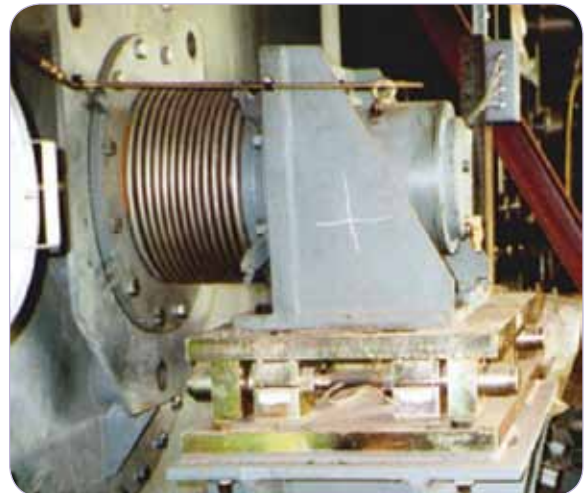

The Americas

- United States** **Vishay Precision Group – BLH**
3 Edgewater Drive • Norwood, MA 02062
Ph: +1-781-298-2200 • Fax: +1-781-762-3988
E-mail: pw.usa@vishaypg.com
- Canada** **Vishay Precision Group – BLH**
14 Steinway, Unit 10 • Toronto • Ontario M9W 6M6
Ph: +1-800-567-6098 (toll free), +1-416-251-2554 • Fax: +1-416-251-2690
E-mail: pw.can@vishaypg.com

Asia

- Taiwan, R.O.C.** **Vishay Precision Group – Weighing Systems***
8F-1, 171, Section 2, Datong Road • Sijhih City, Taipei 22183
Ph: +886-2-8692-6888 • Fax: +886-2-8692-6818
E-mail: pw.roc@vishaypg.com
*Asia except China
- P.R. China** **Vishay Precision Group – Weighing Systems**
A8220, Shanghai Jia Hua Business Center
No. 808 Hong Qiao Road • Shanghai 200030
Ph: +86-21-6448-6090, Ext. 6098 • Fax: +86-21-6448-6070
E-mail: pw.prc@vishaypg.com
- Israel** **Vishay Precision Group – Weighing Systems**
2 HaOfan Street • Holon 58814
Ph: +972-3-557-0888 • Fax: +972-3-556-8116
E-mail: pw.il@vishaypg.com

Europe

- United Kingdom** **Vishay Precision Group – Nobel Weighing Systems**
Airedale House • Canal Road • Bradford BD2 1AG
Ph: +44-1274-782229 • Fax: +44-1274-782230
E-mail: pw.uk@vishaypg.com
- Germany** **Vishay Precision Group – Nobel Weighing Systems**
Tatschenweg 1 • 74078 Heilbronn
Ph: +49-7131-39099-0 • Fax: +49-7131-39099-229
E-mail: pw.de@vishaypg.com
- France** **Vishay Precision Group – Nobel Weighing Systems**
10 Rue Francis Vovelle • 28000 Chartres
Ph: +33-2-37-33-31-25 • Fax: +33-2-37-33-31-29
E-mail: pw.fr@vishaypg.com
- Sweden** **Vishay Precision Group – Nobel Weighing Systems**
P.O. Box 423 • SE-691 27 Karlskoga
Ph: +46-586-63000 • Fax: +46-586-63099
E-mail: pw.se@vishaypg.com
- Norway** **Vishay Precision Group – Nobel Weighing Systems**
Brobekkveien 80 • 0582 Oslo
Ph: +47-22-88-40-90 • Fax: +47-22-88-40-99
E-mail: pw.no@vishaypg.com